

28 CHANNELS LED DRIVER EVALUATION BOARD GUIDE

DESCRIPTION

IS31FL3235A is comprised of 28 constant current channels each with independent PWM control, designed for driving LEDs, PWM frequency can be 3kHz or 22kHz. The output current of each channel can be set at up to 38mA (Max.) by an external resistor and independently scaled by a factor of 1, 1/2, 1/3 and 1/4. The average LED current of each channel can be changed in 256 steps by changing the PWM duty cycle through an I2C interface.

The chip can be turned off by pulling the SDB pin low or by using the software shutdown feature to reduce power consumption.

FEATURES

- 2.7V to 5.5V supply
- I2C interface, automatic address increment function
- Internal reset register
- Modulate LED brightness with 256 steps PWM
- Each channel can be controlled independently
- Each channel can be scaled independently by 1, 1/2, 1/3 and 1/4
- PWM frequency selectable
 - 3kHz (Default)
 - 22kHz
- -40°C to +85°C temperature range
- ESD HBM 8kV
- QFN-36 (4mm × 4mm) package

QUICK START

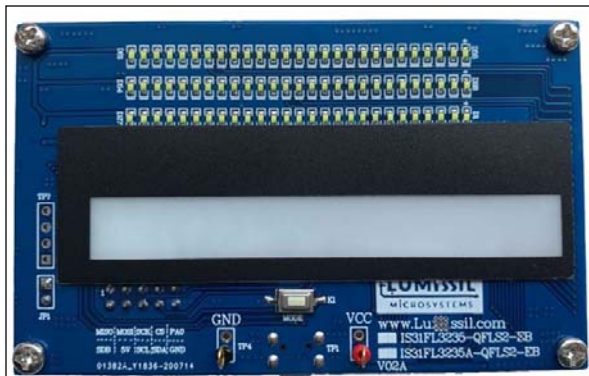

Figure 1: Photo of IS31FL3235A Evaluation Board

RECOMMENDED EQUIPMENT

- 5.0V, 2A power supply

ABSOLUTE MAXIMUM RATINGS

- ≤ 5.5V power supply

Caution: Do not exceed the conditions listed above, otherwise the board will be damaged.

PROCEDURE

The IS31FL3235A evaluation board is fully assembled and tested. Follow the steps listed below to verify board operation.

Caution: Do not turn on the power supply until all connections are completed.

- 1) Connect the ground terminal of the power supply to the GND and the positive terminal to the VCC. Or connect the DC power to the connector (TP1&TP4).
- 2) Turn on the power supply and pay attention to the supply current. If the current exceeds 1.2A, please check for circuit fault.
- 3) Enter the desired mode of display by toggling the MODE button.

EVALUATION BOARD OPERATION

The IS31FL3235A evaluation board has two display modes. Toggling the MODE button (K1) can switch the modes.

- 1) White LED Mode: White LEDs in three rows (27 LEDs in each row) are light as raining effect.
- 2) RGB Mode: Nine RGBs in the middle of the board will show color flowing effect.

Note: IS31FL3235A solely controls the FxLED function on the evaluation board.

ORDERING INFORMATION

Part No.	Temperature Range	Package
IS31FL3235A-QFLS2-EB	-40°C to +85°C (Industrial)	QFN-36, Lead-free

Table 1: Ordering Information

For pricing, delivery, and ordering information, please contacts Lumissil's analog marketing team at analog@Lumissil.com or (408) 969-6600.

28 CHANNELS LED DRIVER EVALUATION BOARD GUIDE

SOFTWARE SUPPORT

JP1 default setting is shorted. If it is set to open, the SDA, SCL and SDB pin are set to high impedance and the on-board MCU will be idle. External I2C and SDB signals can be connected to TP4 to control the IS31FL3235A LED driver. During external control mode, toggling the MODE button (K1) can switch the power of single blue color LED and power of RGB LED.

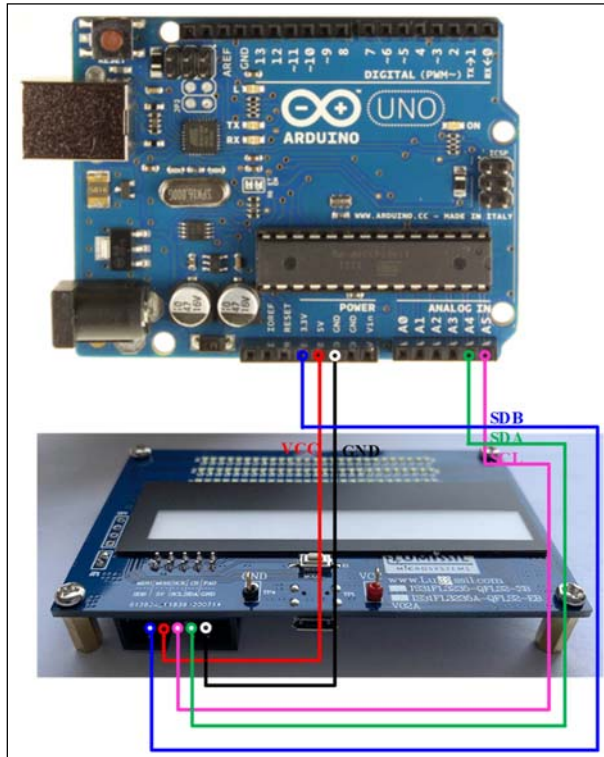

Figure 2: Photo of Arduino UNO connected to Evaluation Board

The steps listed below are an example using the Arduino for external control.

The Arduino hardware consists of an Atmel microcontroller with a bootloader allowing quick firmware updates. First download the latest Arduino Integrated Development Environment IDE (1.6.12 or greater) from www.arduino.cc/en/Main/Software. Also download the Wire.h library from www.arduino.cc/en/reference/wire and verify that pgmspace.h is in the directory ...program Files(x86)/Arduino/hardware/tools/avr/avr/include/avr/. Then download the latest Arduino IS31FL3235A test firmware (sketch) from the Lumissil website <http://www.lumissil.com/products/led-driver/fxled>.

- 1) Open JP1.
- 2) Connect the 5 pins from Arduino board to IS31FL3235A EVB:
 - a) Arduino 5V pin to IS31FL3235A EVB VCC.
 - b) Arduino GND to IS31FL3235A EVB GND.
 - c) Arduino SDA (A4) to IS31FL3235A EVB SDA.
 - d) Arduino SCL (A5) to IS31FL3235A EVB SCL.
 - e) If Arduino uses 3.3V MCU VCC, connect 3.3V to IS31FL3235A EVB SDB, if Arduino uses 5.0V MCU VCC, connect 5.0V to EVB SDB.
(Arduino UNO MCU VCC is 5V, so SDB can be 5V or 3.3V)
- 3) Use the test code in appendix II or download the test firmware (sketch) from the Lumissil website, and copy the code to Arduino IDE, compile and upload to Arduino.
- 4) Run the Arduino code for desired mode setting by Arduino code.
- 5) During external control mode, toggling the MODE button (K1) can switch the power of single color LEDs and power of RGB LEDs.

Please refer to the datasheet to get more information about IS31FL3235A.

28 CHANNELS LED DRIVER EVALUATION BOARD GUIDE

A Division of **LSI**

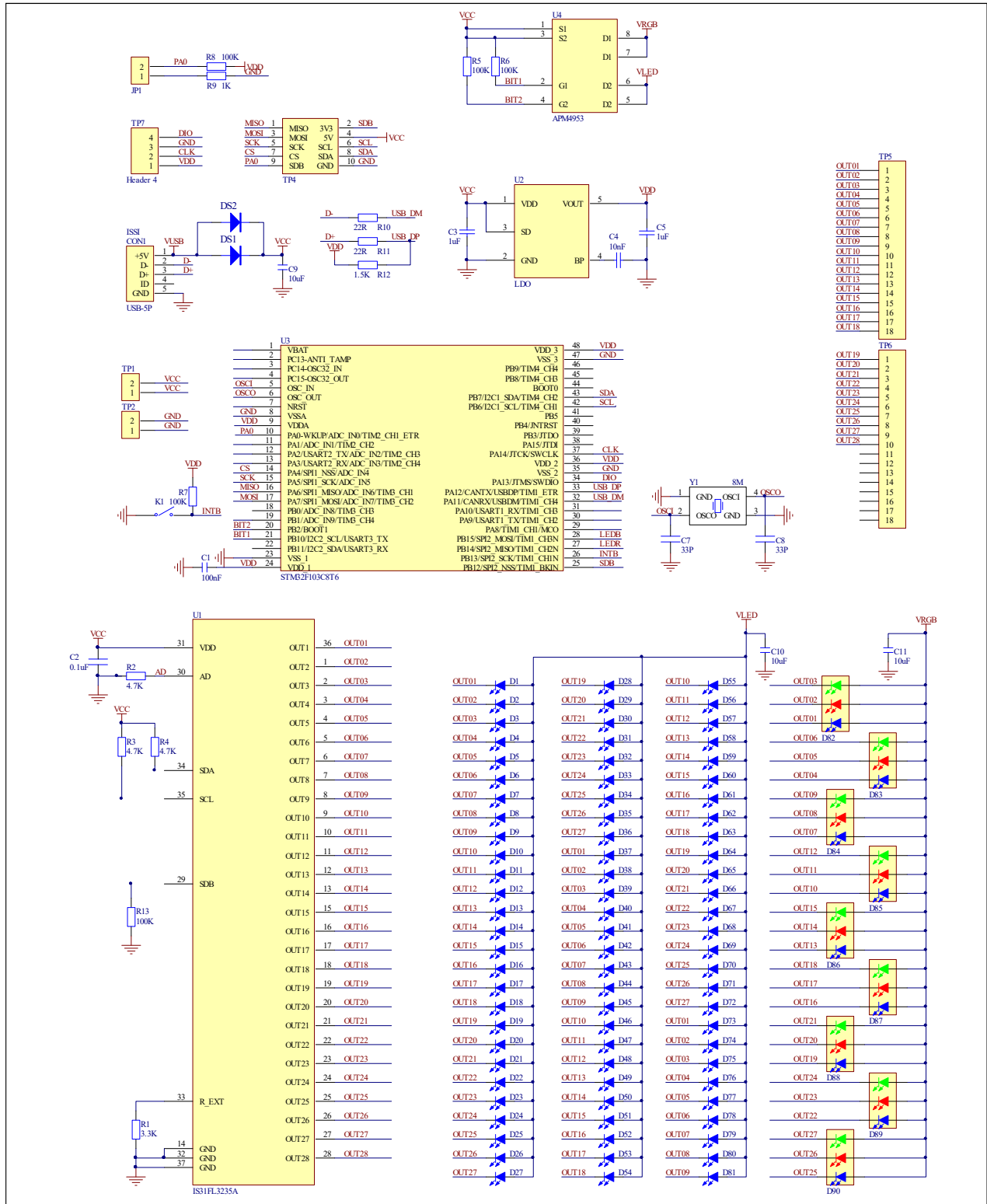

Figure 3: IS32FL3235A Application Schematic

28 CHANNELS LED DRIVER EVALUATION BOARD GUIDE

BILL OF MATERIALS

Name	Symbol	Description	Qty	Supplier	Part No.
LED Driver	U1	28CH FxLED Driver	1	Lumissil	IS31FL3235A
LDO	U2	Low-dropout Regulator	1	PAM	PAM3101
MCU	U3	Microcontroller	1	STM	STM32F103C8T6
PMOS	U4	Dual PMOS	1	ANPEC	APM4953
Crystal	Y1	Crystal, 8MHz	1	JB	HC-49S
LED	D1~D81	Diode, LED Blue, SMD	81	Everlight	19-217/BHC-ZL1M2RY/3T
LED	D82~D90	Diode, LED RGB, SMD	9	Everlight	99-235/RSGBB7C-A22/2D or 99-235/RGBC/TR8
Diode	DS1,DS2	Diode, SMD	2	DIODES	DFLS240
Resistor	R1	RES,3.3k,1/10W,±5%,SMD	1	Yageo	RC0603JR-073K3L
Resistor	R2,R3,R4	RES,4.7k,1/10W,±5%,SMD	3	Yageo	RC0603JR-074K7L
Resistor	R5,R6,R7, R8,R13	RES,100k,1/10W,±5%,SMD	5	Yageo	RC0603JR-07100KL
Resistor	R9	RES,1k,1/10W,±5%,SMD	1	Yageo	RC0603JR-071KL
Resistor	R10,R11	RES,22R,1/10W,±5%,SMD	2	Yageo	RC0603JR-0722RL
Resistor	R12	RES,1.5k,1/10W,±5%,SMD	1	Yageo	RC0603JR-071K5L
Capacitor	C1,C2	CAP,100nF,16V,±20%,SMD	2	Yageo	CC0603MRX7R7BB104
Capacitor	C3,C5	CAP,1µF,16V,±10%,SMD	2	Yageo	AC0805KKX7R7BB105
Capacitor	C4	CAP,10nF,16V,±10%,SMD	1	Yageo	CC0603KRX7R7BB103
Capacitor	C7,C8	CAP,33pF,50V,±5%,SMD	2	Yageo	CQ0603JRNPO9BN360
Capacitor	C9,C10,C11	CAP,10µF,16V,±20%,SMD	3	Yageo	CC0805MKY5V6BB106
Button	K1	Button SMD	1		

Bill of Materials, refer to Figure 3 above.

28 CHANNELS LED DRIVER EVALUATION BOARD GUIDE

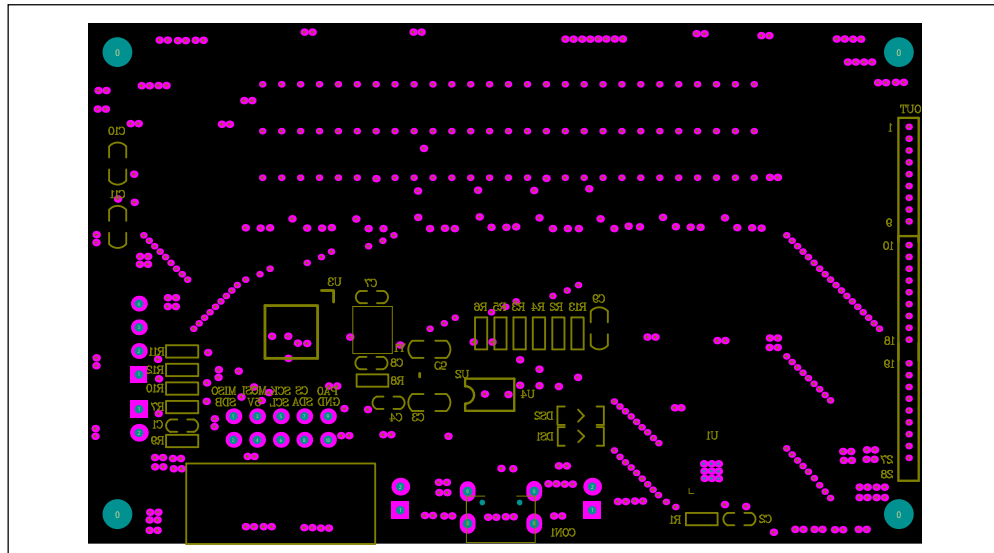

Figure 6: Board Component Placement Guide - Bottom Layer

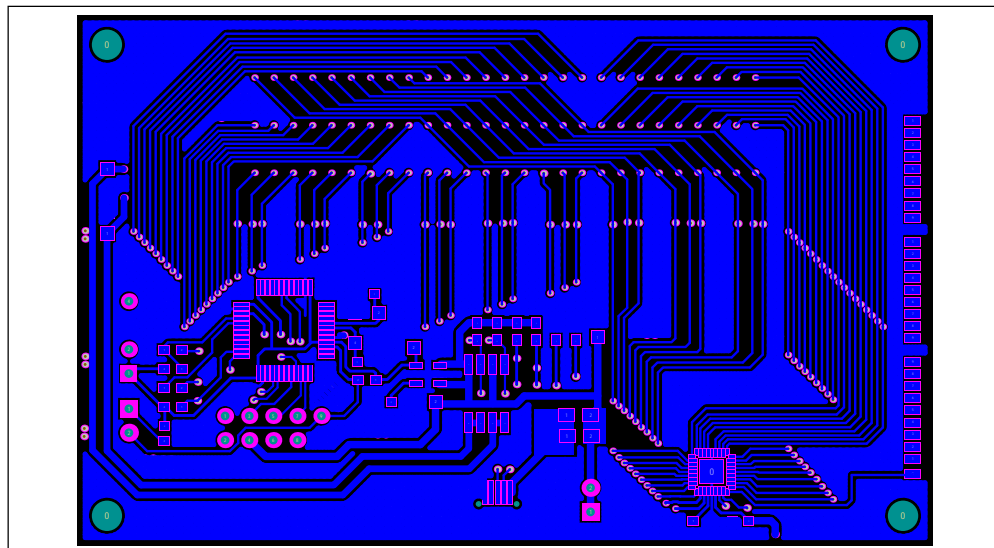

Figure 7: Board PCB Layout - Bottom Layer

Copyright © 2021 Lumissil Microsystems. All rights reserved. Lumissil Microsystems reserves the right to make changes to this specification and its products at any time without notice. Lumissil Microsystems assumes no liability arising out of the application or use of any information, products or services described herein. Customers are advised to obtain the latest version of this device specification before relying on any published information and before placing orders for products.

Lumissil Microsystems does not recommend the use of any of its products in life support applications where the failure or malfunction of the product can reasonably be expected to cause failure of the life support system or to significantly affect its safety or effectiveness. Products are not authorized for use in such applications unless Lumissil Microsystems receives written assurance to its satisfaction, that:

- a.) the risk of injury or damage has been minimized;
- b.) the user assume all such risks; and
- c.) potential liability of Lumissil Microsystems is adequately protected under the circumstances

28 CHANNELS LED DRIVER EVALUATION BOARD GUIDE

REVISION HISTORY

Revision	Detail Information	Data
R1.0	Initial Release	2012.11.18
A	Translate Page to English	2015.10.13
B	<ol style="list-style-type: none"> 1. Update schematic and PCB. 2. Update bill of materials. 3. Add IS31FL3235A option 4. Add Arduino control guide 5. AD pin description: EVB code: AD=GND, Ext control: AD=VDD(Via R5) 	2017.05.04
C	Remove IS31FL3235 description	2017.08.22
D	Update to new MCU STM32F103C8T6, update schematic and PCB layout	2020.08.04
E	Update the BOM	2021.06.04

28 CHANNELS LED DRIVER EVALUATION BOARD GUIDE

APPENDIX I: Rev. C Guide

DESCRIPTION

IS31FL3235A is comprised of 28 constant current channels each with independent PWM control, designed for driving LEDs, PWM frequency can be 3kHz or 22kHz. The output current of each channel can be set at up to 38mA (Max.) by an external resistor and independently scaled by a factor of 1, 1/2, 1/3 and 1/4. The average LED current of each channel can be changed in 256 steps by changing the PWM duty cycle through an I2C interface.

FEATURES

- 2.7V to 5.5V supply
- I2C interface, automatic address increment function
- Internal reset register
- Modulate LED brightness with 256 steps PWM
- Each channel can be controlled independently
- Each channel can be scaled independently by 1, 1/2, 1/3 and 1/4
- QFN-36 (4mm × 4mm) package

QUICK START



Figure 8: Photo of IS31FL3235A Evaluation Board
(LPC922 Version)

RECOMMENDED EQUIPMENT

- 5.0V, 1A power supply

ABSOLUTE MAXIMUM RATINGS

- ≤ 5.5V power supply

Caution: Do not exceed the conditions listed above, otherwise the board will be damaged.

PROCEDURE

The IS31FL3235A evaluation board is fully assembled and tested. Follow the steps listed below to verify board operation.

Caution: Do not turn on the power supply until all connections are completed.

- 4) If using external DC power supply connect the ground terminal of the power supply to the evaluation board's GND pin and the positive terminal to the VCC pin. The evaluation board can also be powered via the Micro USB connector.
- 5) Turn on the power supply or plug in the Micro-USB to the EVB and pay attention to the supply current. If the current exceeds 1A, please check for circuit fault.
- 6) Enter the desired mode of display by toggling the MODE button (K1).

EVALUATION BOARD OPERATION

The evaluation board is controlled by LPC936 (8051 core). IS31FL3235A evaluation board demonstrates the white LEDs mode and RGB modes by switching between modes when the K1 button is pressed.

- 3) White LED Mode: White LEDs in three rows (27 LEDs in each row) are light as raining effect.
- 4) RGB Mode: Nine RGBs in the middle of the board will show color flowing effect.

Note: IS31FL3235A solely controls the FxLED function on the evaluation board.

28 CHANNELS LED DRIVER EVALUATION BOARD GUIDE

SOFTWARE SUPPORT

JP1 default setting is closed (jumper on). If it is open (no jumper), the on-board MCU will configure its own I2C/SDB/AD pins to High Impedance status so an external source can driver the I2C/SDB signals to control the IS31FL3235A LED driver, the on-board MCU will also configure the U2 to open the VRGB and close the VLED. (Some early boards we provided still only open VLED)

The AD pin is pulled high via R5 setting the device address of IS31FL3235A to 0x7E (0x3F for 7bit address format).

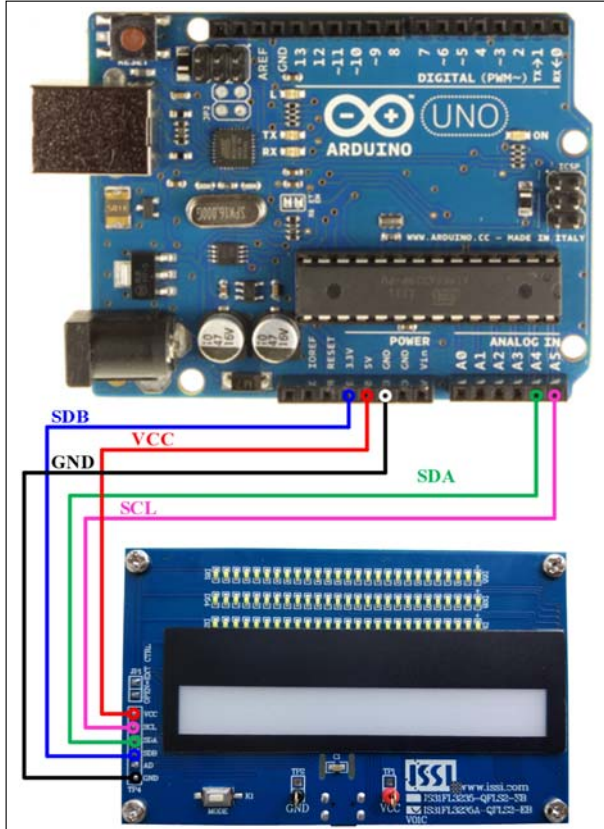

Figure 9: Photo of Arduino UNO connected to Evaluation Board

The steps listed below are an example using the Arduino for external control.

The Arduino hardware consists of an Atmel microcontroller with a bootloader allowing quick firmware updates. First download the latest Arduino Integrated Development Environment IDE (1.6.12 or greater) from www.arduino.cc/en/Main/Software. Also download the Wire.h library from www.arduino.cc/en/reference/wire and verify that

pgmspace.h is in the directory ...program Files(x86)/Arduino/hardware/tools/avr/avr/include/avr /. Then download the latest IS31FL3235A test firmware (sketch) from the Lumissil website <http://www.lumissil.com/products/led-driver/fxled>.

- 1) Open JP1.
- 2) Connect the 5 pins from Arduino board to IS31FL3235A EVB:
 - a) Arduino 5V pin to IS31FL3235A EVB VCC (TP4).
 - b) Arduino GND to IS31FL3235A EVB GND (TP4).
 - c) Arduino SDA (A4) to IS31FL3235A EVB SDA.
 - d) Arduino SCL (A5) to IS31FL3235A EVB SCL.
 - e) If Arduino use 3.3V MCU VCC, connect 3.3V to IS31FL3235A EVB SDB, if Arduino use 5.0V MCU VCC, connect 5.0V to EVB SDB.
(Arduino UNO is 5.0V, so SDB=5.0V)
- 3) Use the test code in appendix I or download the test firmware (sketch) from the Lumissil website, a .txt file and copy the code to Arduino IDE, compile and upload to Arduino.
- 4) Run the Arduino code and the initial mode will change the RGB LED brightness every second. Note: the white color LEDs cannot be controlled when the onboard LPC936 is disabled.
(Some early board we provided is still controlling the white color LED)
- 5) In EVB code, the AD pin is pulled low via P0.1 of MCU, so the device address is 0x78. When JP1 is open, the AD pin will be pulled high via R5 and the default IS31FL3235A device address becomes 0x7E (AD=VCC, 7bit format is 0x3F). If AD=H, the IS31FL3235A address can be changed by connecting the AD in TP4 as follows:
 - a) AD=GND, device address=0x78 (7bit format is 0x3C).
 - b) AD=SCL, device address=0x7A (7bit format is 0x3D).
 - c) AD=SDA, device address=0x7C (7bit format is 0x3E).

If AD=GND or low default, it may be pulled low by MCU in early version FW so it is fixed to GND and can't be modified.

Please refer to the datasheet to get more information about IS31FL3235A.

28 CHANNELS LED DRIVER EVALUATION BOARD GUIDE

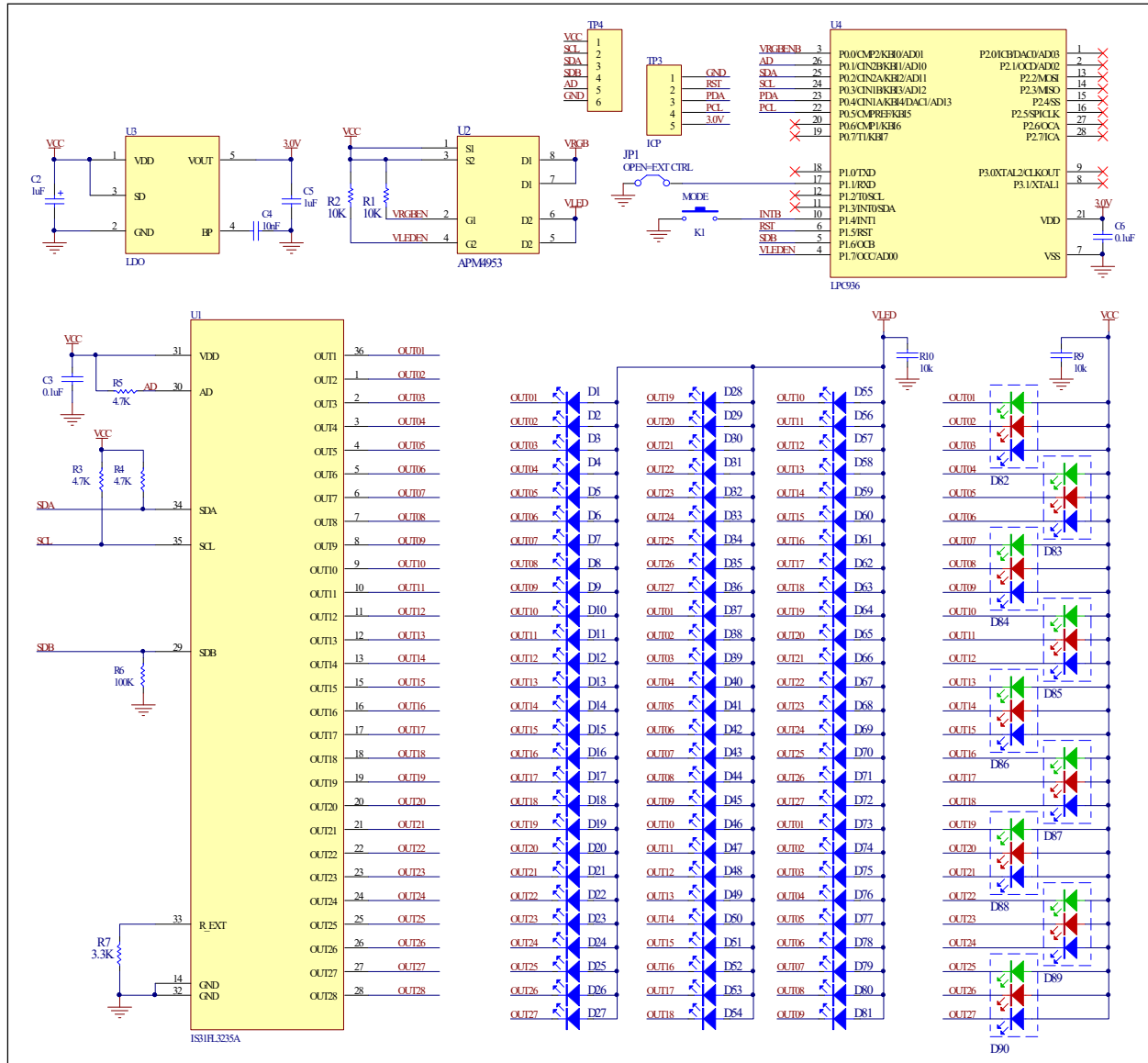

Figure 10: IS31FL3235A Application Schematic

28 CHANNELS LED DRIVER EVALUATION BOARD GUIDE

BILL OF MATERIALS

Name	Symbol	Description	Qty	Supplier	Part No.
LED Driver	U1	28 CH FxLED Driver	1	Lumissil	IS31FL3235A
PMOS	U2	Dual PMOS	1	ANPEC	APM4953
LDO	U3	Low-dropout Regulator	1	SGMICRO	SGM2019
MCU	U4	Microcontroller	1	NXP	LPC936
Diode	D1~D81	Diode, LED White, SMD	81	Everlight	19-217/BHC-ZL1M2RY/3T
Diode	D82~D90	Diode, LED RGB, SMD	9	Everlight	99-235/RSGBB7C-A22/2D or 99-235/RGBC/TR8
Diode	DS1,DS2	Diode, SMD	2	DIODES	DFLS240
Resistor	R1,R2, R9,R10	RES,10k,1/16W,±5%,SMD R9 & R10 is for discharging the VCC when switch mode	4	Yageo	RC0603JR-0710KL
Resistor	R3,R4,R5	RES,4.7k,1/16W,±5%,SMD	3	Yageo	RC0603JR-074K7L
Resistor	R6	RES,100k,1/16W,±5%,SMD	1	Yageo	RC0603JR-07100KL
Resistor	R7	RES,3.3k,1/16W,±5%,SMD	1	Yageo	RC0603JR-0713K3L
Resistor	R8	NC			
Capacitor	C1	CAP,10µF,16V,±20%,SMD	1	Yageo	CC0603KKX7R9BB106
Capacitor	C2,C5	CAP,1µF,16V,±20%,SMD	2	Yageo	CC0603KKX7R9BB105
Capacitor	C3,C6	CAP,0.1µF,16V,±20%,SMD	2	Yageo	CC0603KKX7R9BB104
Capacitor	C4	CAP,10nF,16V,±20%,SMD	1	Yageo	CC0603KKX7R9BB103
Button	K1	Button SMD	1		
Connector	DC IN	Micro USB connector	1		

Bill of Materials, refer to Figure 10 above.

28 CHANNELS LED DRIVER EVALUATION BOARD GUIDE

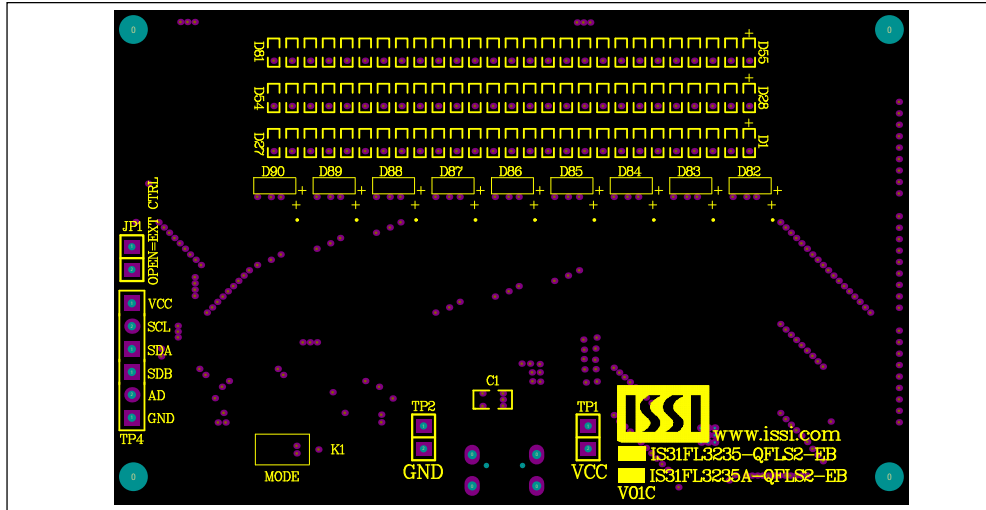

Figure 11: Board Component Placement Guide - Top Layer

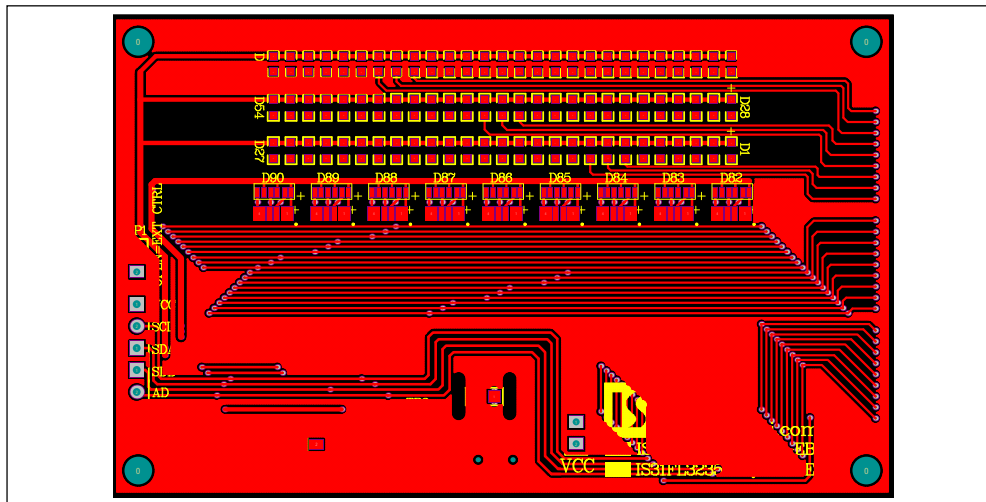

Figure 12: Board PCB Layout - Top Layer

28 CHANNELS LED DRIVER EVALUATION BOARD GUIDE

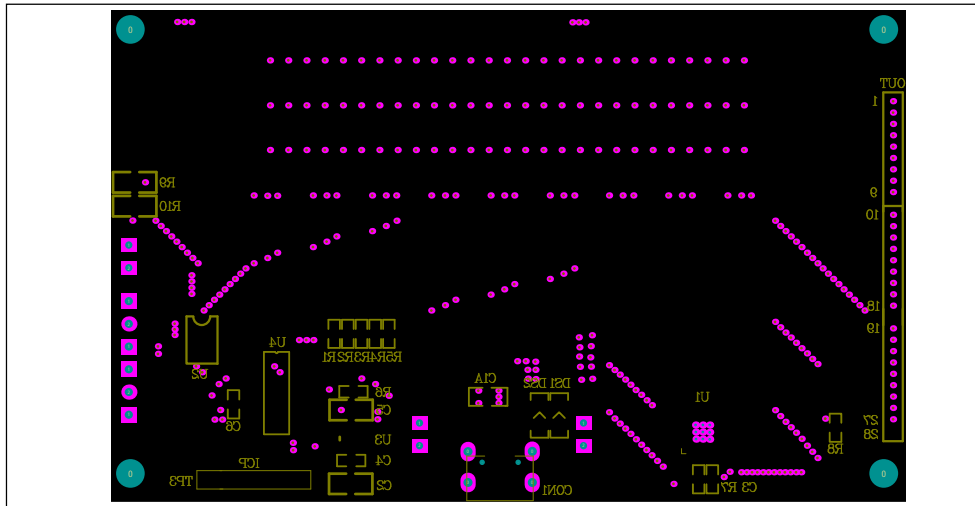

Figure 13: Board Component Placement Guide - Bottom Layer

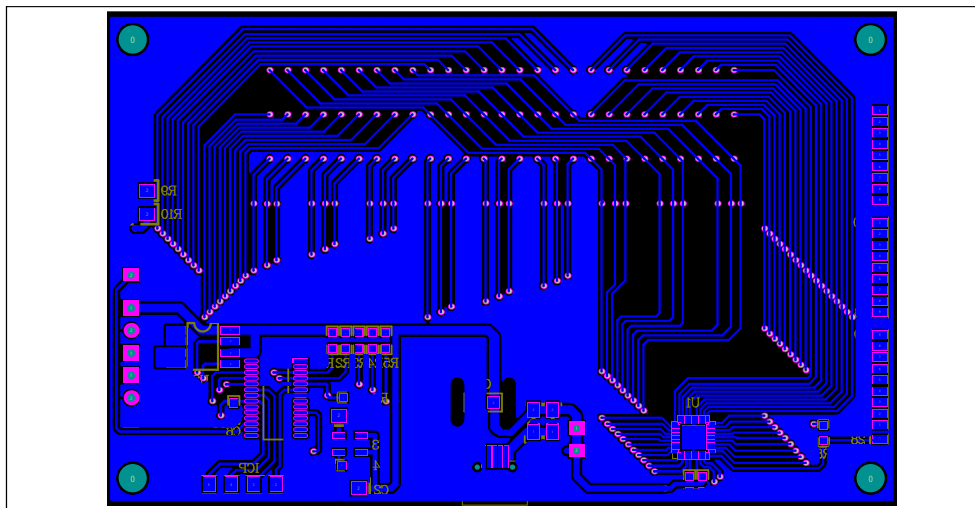

Figure 14: Board PCB Layout - Bottom Layer

28 CHANNELS LED DRIVER EVALUATION BOARD GUIDE

APPENDIX II: IS31FL3235A Arduino Test Code V01B

```

#include<Wire.h>
#include<avr/pgmspace.h>
#define Addr_VCC 0x78//Some early boards we provided the AD pin is set to low, so if you couldn't make it work, try 0x7E as well
//7 bit format is 0x3F
//if AD is default low by MCU it can't be configured to other connection.

byte PWM_Gamma64[64]=
{
  0x00,0x01,0x02,0x03,0x04,0x05,0x06,0x07,
  0x08,0x09,0x0b,0x0d,0x0f,0x11,0x13,0x16,
  0x1a,0x1c,0x1d,0x1f,0x22,0x25,0x28,0x2e,
  0x34,0x38,0x3c,0x40,0x44,0x48,0x4b,0x4f,
  0x55,0x5a,0x5f,0x64,0x69,0x6d,0x72,0x77,
  0x7d,0x80,0x88,0x8d,0x94,0x9a,0xa0,0xa7,
  0xac,0xb0,0xb9,0xbf,0xc6,0xcb,0xcf,0xd6,
  0xe1,0xe9,0xed,0xf1,0xf6,0xfa,0xfe,0xff
};

void setup() {
  // put your setup code here, to run once:
  Wire.begin();
  Wire.setClock(400000);//I2C 400kHz
  pinMode(4,OUTPUT);//SDB
  digitalWrite(4,HIGH);//SDB_HIGH
  Init_FL3235A();
}

void loop() {
  // put your main code here, to run repeatedly:
  IS31FL3235A_mode1();//breath mode
}

void IS_IIC_WriteByte(uint8_t Dev_Add,uint8_t Reg_Add,uint8_t Reg_Dat)
{
  Wire.beginTransmission(Dev_Add/2);
  Wire.write(Reg_Add); // sends regaddress
  Wire.write(Reg_Dat); // sends regaddress
  Wire.endTransmission(); // stop transmitting
}

void Init_FL3235A(void)
{
  uint8_t i = 0;
  for(i=0x2A;i<=0x45;i++)
  {
    IS_IIC_WriteByte(Addr_VCC,i,0xff);//turn on all LED
  }
}

```

28 CHANNELS LED DRIVER EVALUATION BOARD GUIDE

```

}

for(i=0x05;i<=0x20;i++)
{
    IS_IIC_WriteByte(Addr_VCC,i,0x00);//write all PWM set 0x00
}

IS_IIC_WriteByte(Addr_VCC,0x25,0x00);//update PWM&Control registers
IS_IIC_WriteByte(Addr_VCC,0x4B,0x01);//frequency setting 22KHz
IS_IIC_WriteByte(Addr_VCC,0x00,0x01);//normal operation
}

void IS31FL3235A_mode1(void)
{
    uint8_t i = 0;
    int8_t j = 0;

    for(i=0x1D;i>=0x05;i-=3)//B LED running
    {
        IS_IIC_WriteByte(Addr_VCC,i,0xFF);//set PWM
        IS_IIC_WriteByte(Addr_VCC,0x25,0x00);//update PWM&Control registers
        delay(100);//100ms
    }
    for(i=0x06;i<=0x20;i+=3)//R LED running
    {
        IS_IIC_WriteByte(Addr_VCC,i,0xFF);//set PWM
        IS_IIC_WriteByte(Addr_VCC,0x25,0x00);//update PWM&Control registers
        delay(100);//100ms
    }
    for(i=0x1F;i>=0x05;i-=3)//G LED running
    {
        IS_IIC_WriteByte(Addr_VCC,i,0xFF);//set PWM
        IS_IIC_WriteByte(Addr_VCC,0x25,0x00);//update PWM&Control registers
        delay(100);//100ms
    }
    for (j=63;j>=0;j--)//all LED breath falling
    {
        for(i=0x05;i<0x20;i++)
        {
            IS_IIC_WriteByte(Addr_VCC,i,PWM_Gamma64[j]);//set all PWM
        }
        IS_IIC_WriteByte(Addr_VCC,0x25,0x00);//update PWM&Control registers
        delay(20);//20ms
    }
    delay(500); //keep on 0.5s
}

```